

Varenummer: 20958426
Beskrivelse: E+G Justerfod
GN 343.3-25-M8-G

Mål

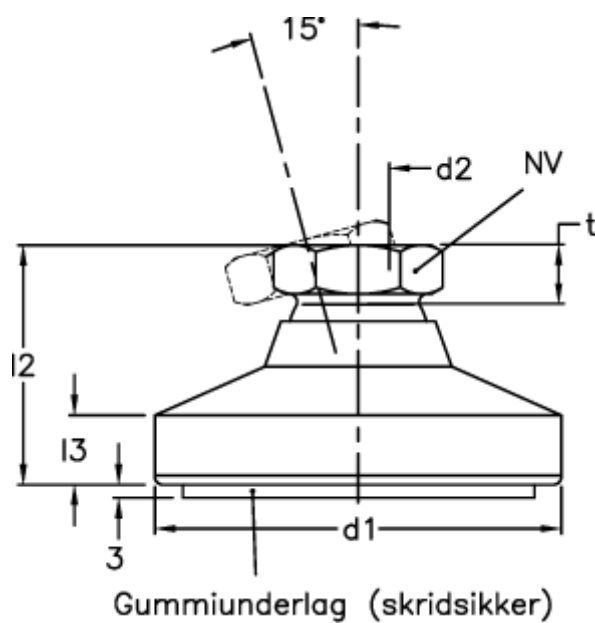

d_1	= 25
d_2	= M 8
l_2	= 18.5
l_3	= 4.0
NV	= 12.0
Statisk belastning (N)	= 5000
t min	= 9.0